

## EA-6B PROWLER

EPIC GLASS

### 1/72 Limited Edition Vacu Cab w. Spraying Masks

Recommended Kit - Hasegawa / For advanced modellers

THIS IS NOT A TOY! Item for adult only

TOTO NIE JE HRAČKA! Určené pre dospelé osoby

Produced & Designed by Geronimo72Art, Slovak Republic

Vacu Cab by Rob-Taurus, Czech Republic

Masks by EDUARD Model Accessories, Czech Republic

#### Manual

1. Carefully study the mask application instructions
2. Always use a new scalpel blade to separate the cabin
3. Cut the cabin with an overlap of approx. 0.5-1 mm
4. Carefully and gradually remove the material until the cabin fits exactly in the designated place on the model
5. Apply the masks according to the instructions
6. Apply a liquid masking agent to protect the remaining surfaces of the canopy surface

#### Warning

1. Do not use sanding papers, cloths and sponges, or sanding and polishing pastes for surface treatment!
2. Use only cotton ear stick with tap water to clean the cabin!
3. Do not use cyanoacrylate or solvent adhesives for gluing the cabin!
4. Use only PVA glue (such as Ultra Glue by Mig)
5. Do not use debonder and tool cleaning agents to clean the cabin - they etch the surface!

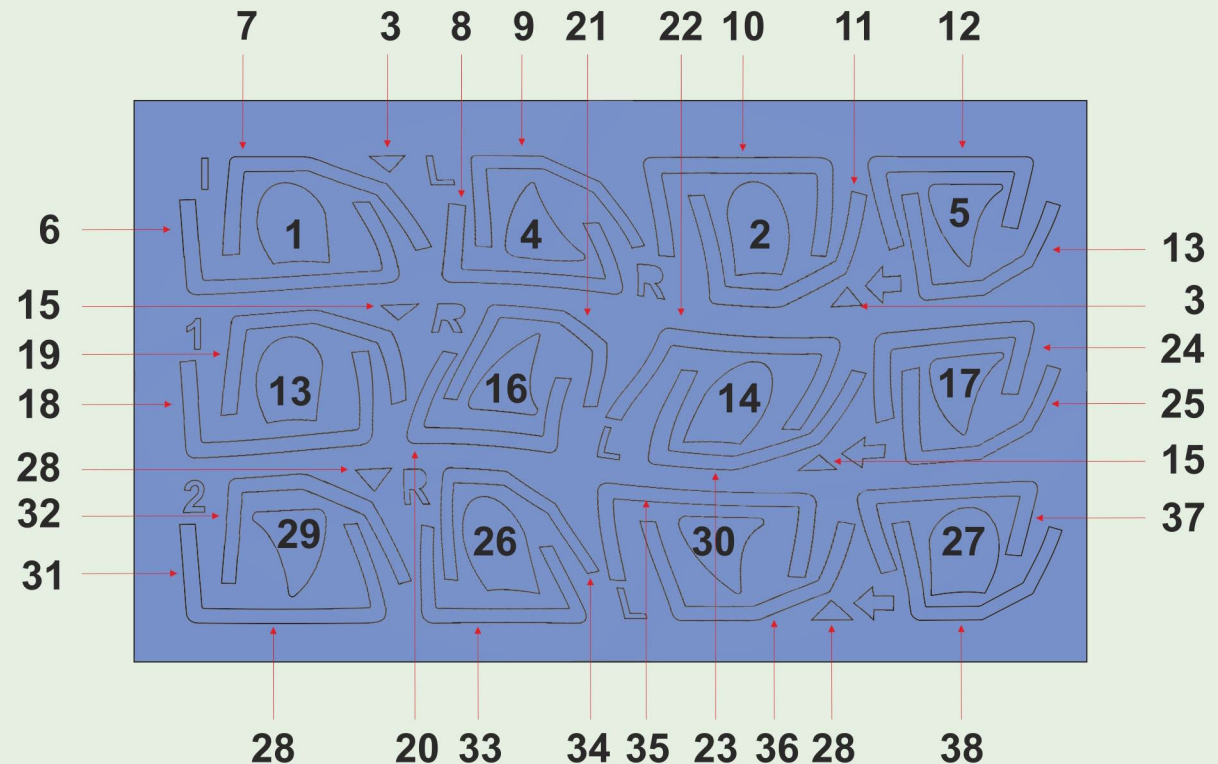

#### Application sequence

1. 1 - Interior - Interior Color
2. 1 - Outside - Seal Color
3. 2 - Outside - Camouflage Color

## EA-6B PROWLER

EPIC GLASS

1 - Apply Inside  
Interior Color  
(inside view)

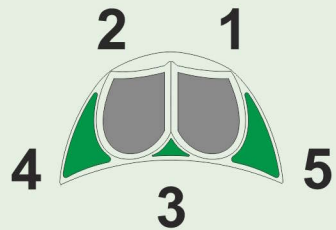

1 - Apply Outside  
Seal Color  
(outside view)

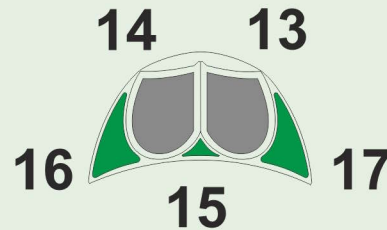

2 - Apply Outside  
Camouflage Color  
(outside view)

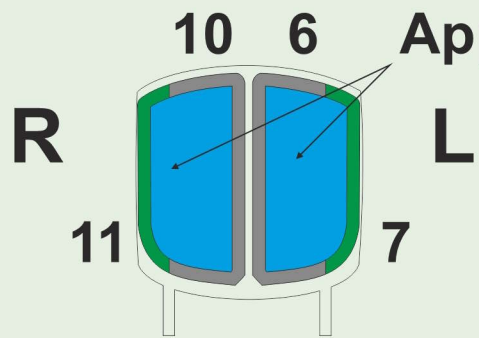
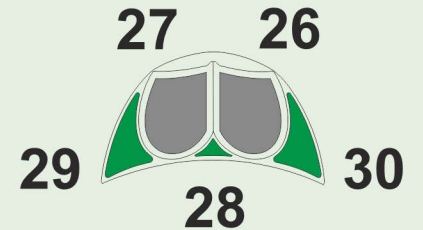

Apply Liquid Mask

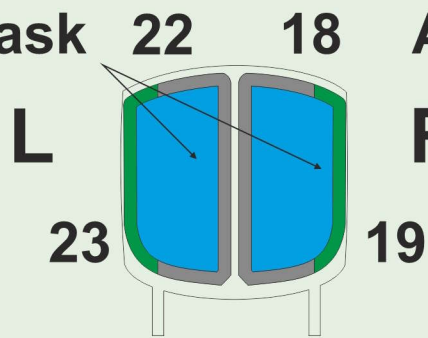

Apply Liquid Mask

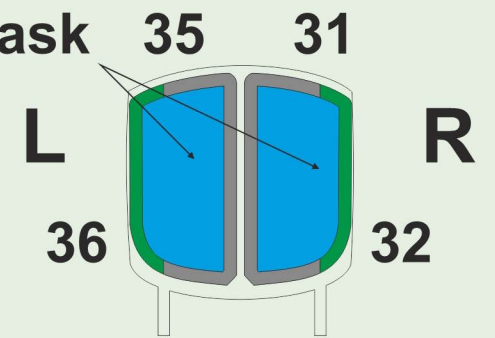

Apply Liquid Mask

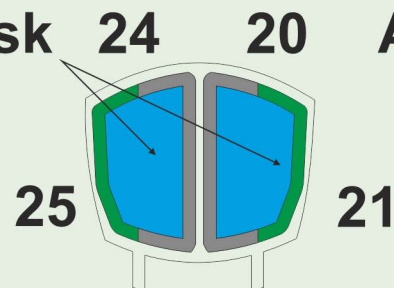

Apply Liquid Mask

